

Parts List

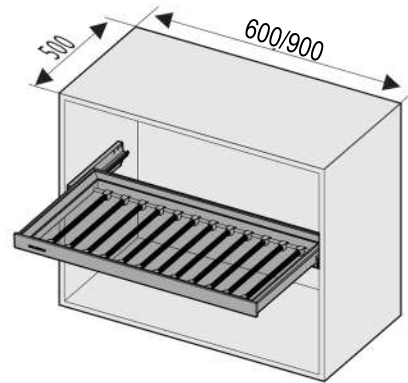
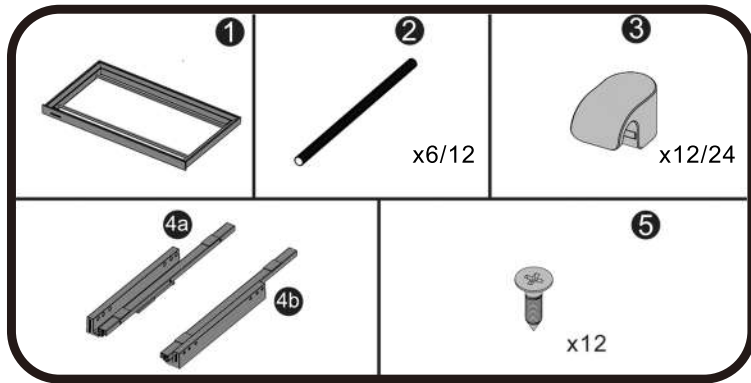
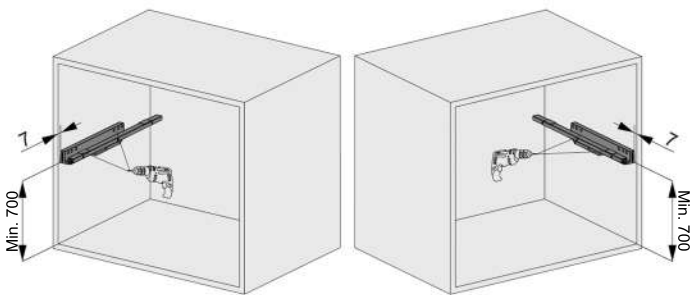

Illustration for Drilling

- 1 Drill 12 holes with \varnothing of 2.5mm each side.



Slider Installation

- 2 Affix the left and right sliders using 12pcs of screws.

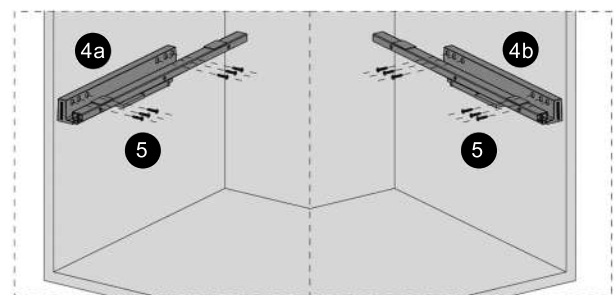

Drilling size (Left)

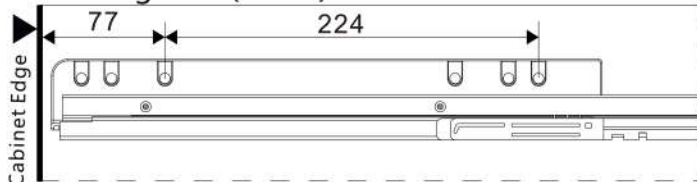

Drilling size (Right)

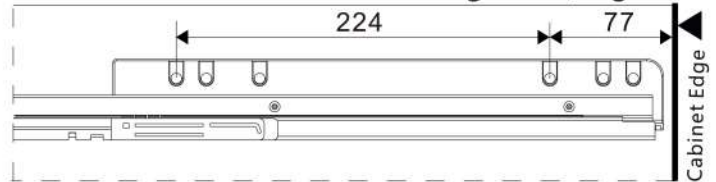

Frame Assembly

- 3 Hold the frame at the illustrated angle (3.1) and push to the sliders (3.2). Make sure that the frame is firmly attached to the velcro.

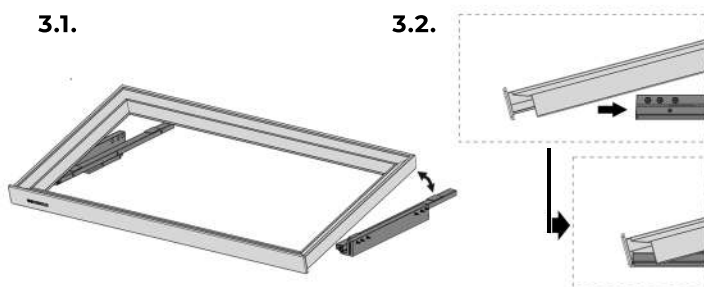

Rack Assembly

- 4 Attach the hooks to each rod (4.1) and install to the frame (4.2).

